

KENWOOD

KEC-600

ELECTRONIC CROSSOVER NETWORK
INSTRUCTION MANUAL

DIVISEUR DE FREQUENCE
MODE D'EMPLOI

AKTIVE FREQUENZWEICHE
BEDIENUNGSANLEITUNG

ELECTRONISCHE CROSSOVER NETWORK
GEBRUIKSAANWIJZING

CROSSOVER ELECTRONICO PER SISTEMI MULTICANALI
ISTRUZIONI PER L'USO

FILTRO SEPARADOR DE FRECUENCIAS ELECTRONICO
MANUAL DE INSTRUCCIONES

KENWOOD CORPORATION

Take the time to read through this instruction manual. Familiarity with installation and operation procedures will help you obtain the best performance from your new electronic crossover network.

For your records

Record the serial number, found on the back of the unit, in the spaces designated on the warranty card, and in the space provided below. Refer to the model and serial numbers whenever you call upon your KENWOOD dealer for information or service on the product.

Model KEC-600 Serial number _____

SAFETY PRECAUTIONS

ENGLISH

▲WARNING

To prevent fire and avoid personal injury in case of accidents.

- When extending the power supply or Ground lead, avoid short circuits by using 0.75mm² (AWG 18) or larger automotive grade cable.
- Check to be sure that no metal objects (tools, needles, coins) are left inside the unit.
- If you smell or see smoke, disconnect the unit immediately and consult your KENWOOD dealer. Continued use can cause a fire or permanent damage to the unit.

▲CAUTION

To keep the unit in proper working order.

- Be sure it's connected to a 12V DC power supply with a minus ground connection.
- Do not open front panel or top bottom cover.
- Do not exposed this unit to direct sunlight or high heat.
- Keep it clean and dry.
- Be sure it is fastened securely and not exposed to excess vibration.

NOTE

- If you have difficulty in installing this unit in your vehicle, please contact your KENWOOD dealer.

Cleaning

1. Always turn the power OFF, before cleaning.
2. Wipe the front panel and other exterior surfaces with a soft dry cloth or a soft cloth lightly moistened with a neutral detergent.

▲CAUTION

- Do not use abrasive pads or paint thinner, benzene or other volatile solvents. These may remove the indicator characters.

CONTENTS

	Page
■ About KEC-600	
FEATURES	4
CONTROLS, CONNECTORS AND INDICATORS	6
■ Installation	
ACCESSORIES.....	8
INSTALLATION PROCEDURE	9
CONNECTIONS	10
INSTALLATION	12
■ Operation	
FRONT OUTPUT ADJUSTMENTS	14
REAR OUTPUT ADJUSTMENTS	15
LOW2 OUTPUT ADJUSTMENTS	16
LOW1 OUTPUT ADJUSTMENTS	17
PARAMETRIC EQUALIZER ADJUSTMENTS.....	18
■ SPECIFICATIONS	19

FEATURES

■ Low-frequency output mode switching

When making the fader adjustment from the Center Unit, the LOW 1 OPERATION and LOW 2 OPERATION switches allow to set the way low-frequency output levels (LOW2, LOW1) are varied. With the FRONT position, the low frequency output level follows the FRONT output level. With the "REAR" position, it follows the REAR output level. With the "F+R" position, the low frequency output level is not affected by the fader adjustment (non-fading sound).

In case the Center Unit has a sub woofer or center output which can be controlled independently, the AUX function allows to control the LOW 1 output level alone. With the "AUX" position, the low frequency output level can be adjusted using the sub woofer or center output level control on the Center Unit.

● Relationship between LOW 1/LOW 2 OPERATION switches and fader adjustment

- FRONT : 3WAY+REAR : 2WAY+Non-Fading Sub woofer

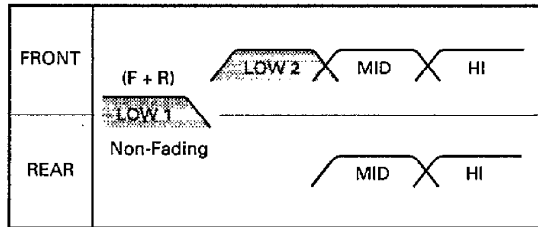
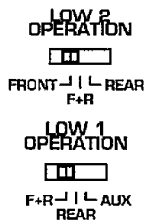

- FRONT : 2WAY+REAR : 3WAY+External level control Sub woofer

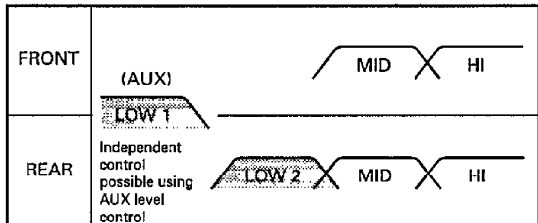
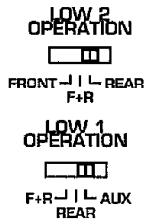

- FRONT : 2WAY+REAR : 4WAY

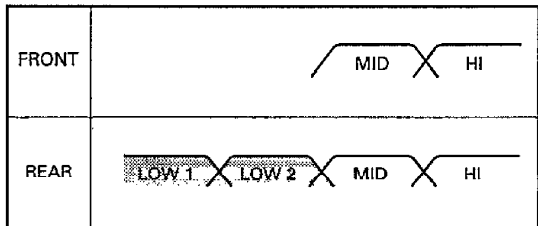
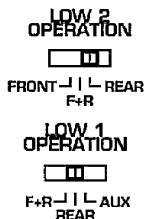

■ MID output ON/THROUGH switching

The ON/THROUGH switch allows to use the unit both with a speaker system containing speaker units for each sound range and with a speaker system using full-range speaker units.

With this switch in the "ON" position, the high frequencies in the MID output can be cut off so that the high-range sound and mid-range sound are separated. With the "THROUGH" position, the high frequencies in the MID output is not cut so that the mid-range output can be supplied to full-range speakers.

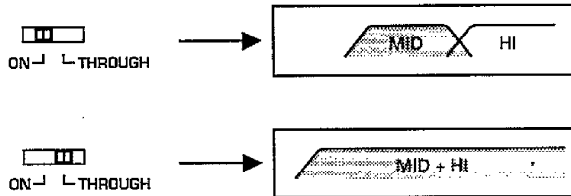

■ Phase switching

By setting the phases of the FRONT MID and REAR MID outputs as the reference phase (0°), the phases of the FRONT HIGH output, REAR HIGH output, LOW 2 output and LOW 1 output can be switched by 180° .

This function allows to make the overall sound connection smooth according to the combinations and installation positions of the speaker units.

■ Parametric equalizer

The parametric equalizer adjusts the level of the LOW 1 or LOW 2 output frequency which can be selected in the range from 30 to 300 Hz.

This function allows to attenuate the frequency which is easily reflected in a specific car or to boost the frequency which is not reproduced well in a specific car.

CONTROLS, CONNECTORS AND INDICATORS

■ CONTROL PANELS

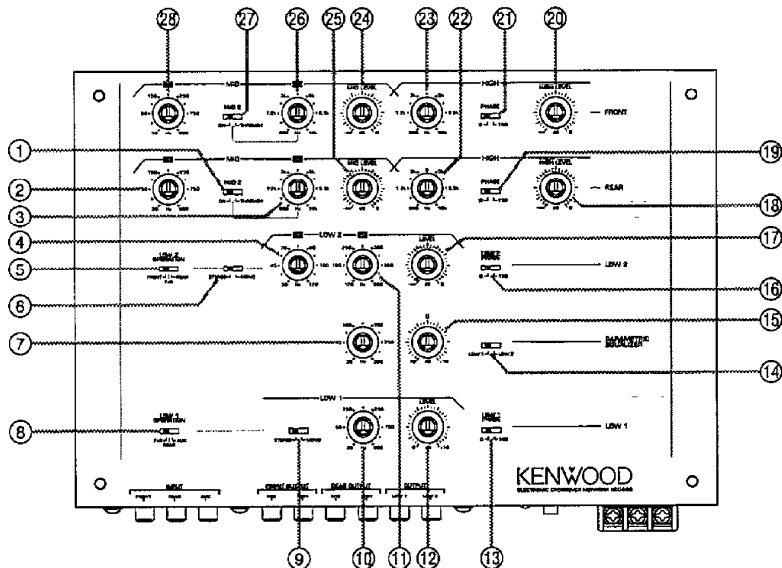

OPERATION SWITCH

- ⑤ LOW2 OPERATION SWITCH
- ⑧ LOW1 OPERATION SWITCH

ON/THROUGH SWITCH

- ② FRONT MID ON/THROUGH SWITCH
- ① REAR MID ON/THROUGH SWITCH

CROSSOVER FREQUENCY CONTROLS

- ③ FRONT HIGH low-cut frequency control
- ⑥ FRONT MID high-cut frequency control
- ④ FRONT MID low-cut frequency control
- ② REAR HIGH low-cut frequency control
- ③ REAR MID high-cut frequency control
- ② REAR MID low-cut frequency control
- ① LOW 2 high cut frequency control
- ④ LOW 2 low-cut frequency control
- ⑩ LOW 1 high-cut frequency control

OUTPUT LEVEL CONTROLS

- ② FRONT HIGH output level control
- ④ FRONT MID output level control
- ③ REAR HIGH output level control
- ⑤ REAR MID output level control
- ⑦ LOW 2 output level control
- ⑫ LOW 1 output level control

PHASE SWITCHES

- ⑨ FRONT HIGH phase switch
- ⑩ REAR HIGH phase switch
- ⑩ LOW 2 phase switch
- ⑬ LOW 1 phase switch

MONO/STEREO SWITCHES

- ⑥ LOW 2 MONO/STEREO switch
- ⑨ LOW 1 MONO/STEREO switch

PARAMETRIC EQUALIZER

- ⑭ LOW 1/LOW 2 switch
- ⑦ Frequency control
- ⑮ Output level control

■ CONNECTOR PANEL

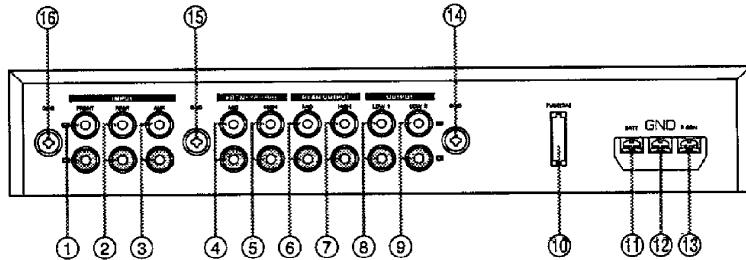

INPUT JACKS

- ① FRONT input jacks
- ② REAR input jacks
- ③ AUX input jacks

OUTPUT JACKS

- ④ FRONT MID output jacks
- ⑤ FRONT HIGH output jacks
- ⑥ REAR MID output jacks
- ⑦ REAR HIGH output jacks
- ⑧ LOW 1 output jacks
- ⑨ LOW 2 output jacks

⑩ Power fuse

⑪ Power supply terminal





⑫ Grounding terminal

⑬ Power control terminal

⑭⑮⑯ Grounding terminals for RCA cords

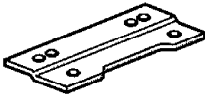
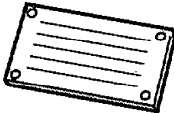
ACCESSORIES

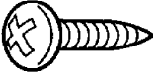
ENGLISH

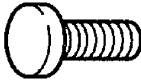
No.	Part name	External View	Number of units
①	Metal fixture		2
②	Acryle panel		1
③	Pan head screw (M3 × 5)		4
④	Pan head screw (M4 × 8)		4
⑤	Tapping screw (φ4 × 14)		4
⑥	Collar		4
⑦	Decorative screw		4

INSTALLATION PROCEDURE

1. Before starting installation, disconnect the negative (−) terminal of the battery. This will prevent short circuits.
2. Connect the Input and Output leads (p.10).
3. Connect the Power control lead (p.10).
4. Connect the Ground lead to the metal body of the car (p.10).
5. Connect the Power supply lead (p.10).
6. Install the unit in the car (p.12).
7. Connect the negative (−) terminal of the battery.

CAUTION

- A short circuit may cause a blown fuse. A short circuit is a serious problem that could also cause a fire. Check the wiring carefully and, if any wires are short-circuited, rewire immediately. If no short-circuits are found, replace the fuse with one having the same rating (see indication on unit).
- Check that no unconnected wires or connectors are in contact with the body of the car. Extraneous noise or current entering the system can cause malfunction or damage.
- When the power of this unit is turned ON while several power amplifiers are connected to the unit, it sometimes happens that the power amplifiers cannot be turned ON because their protection functions are activated due to a large amount of current (rush current) flowing at this moment.
In such a case, modify the connections taking the following points in consideration.
 - Connect the power cord of the amplifier directly to the ⊕ terminal of the battery.
 - Connect the grounding cord of the amplifier securely to a metal chassis of car that is connected electrically with the ⊖ terminal of the battery.
 - Replace the battery with a battery with a larger capacity.

CONNECTIONS

ENGLISH

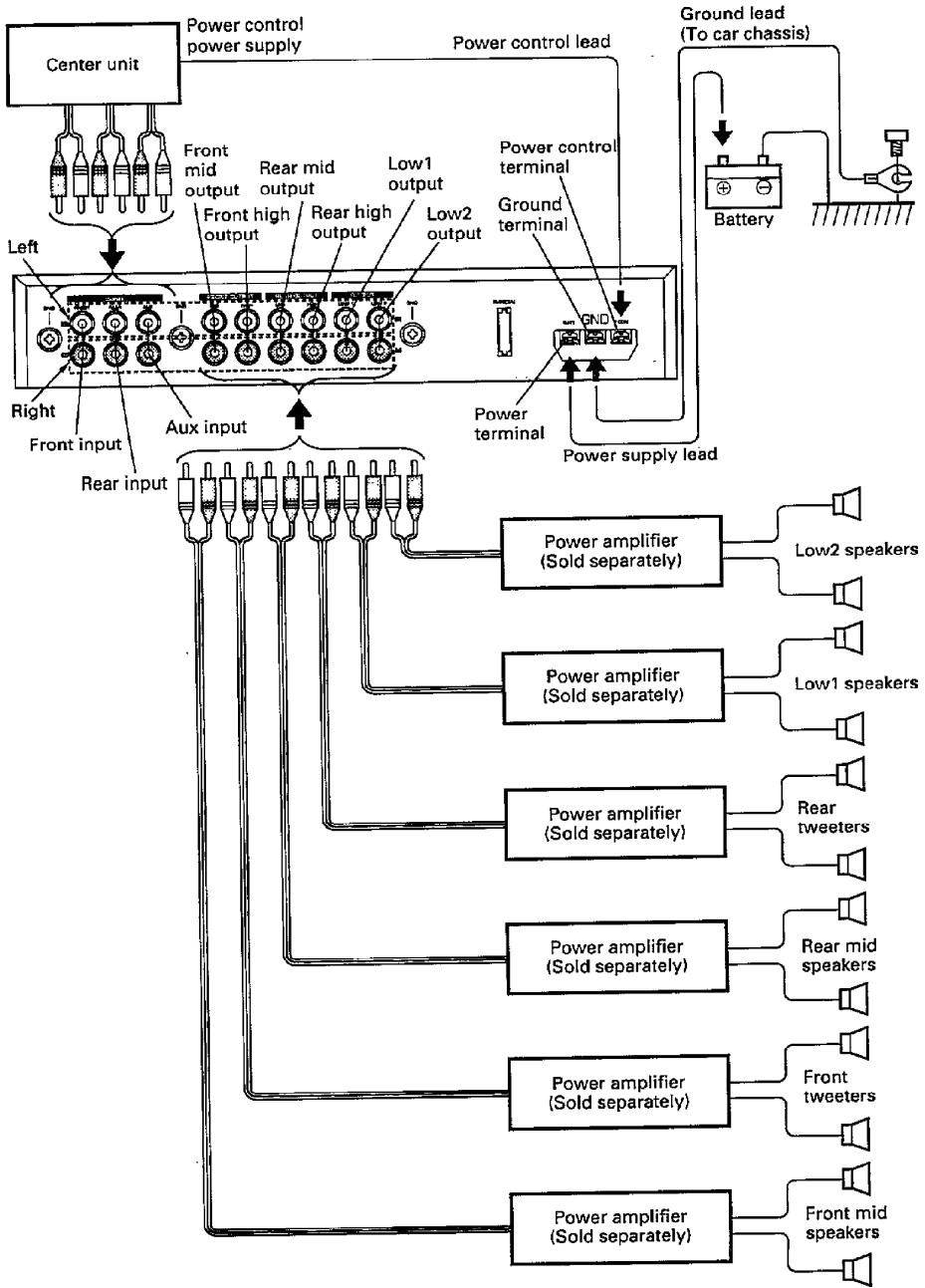

■ How to use the ground screws

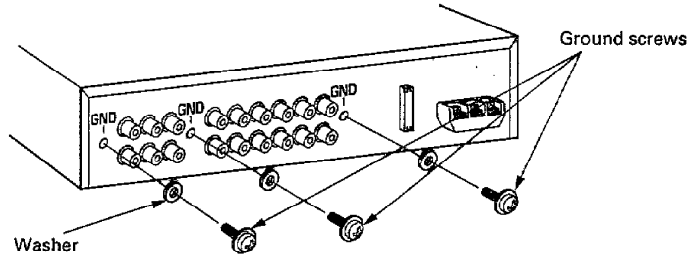

● Use example 1

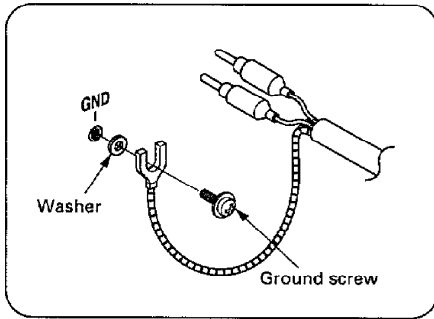

● Use example 2

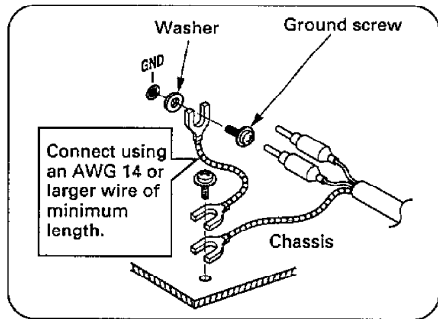

■ Power amplifier power control connection method

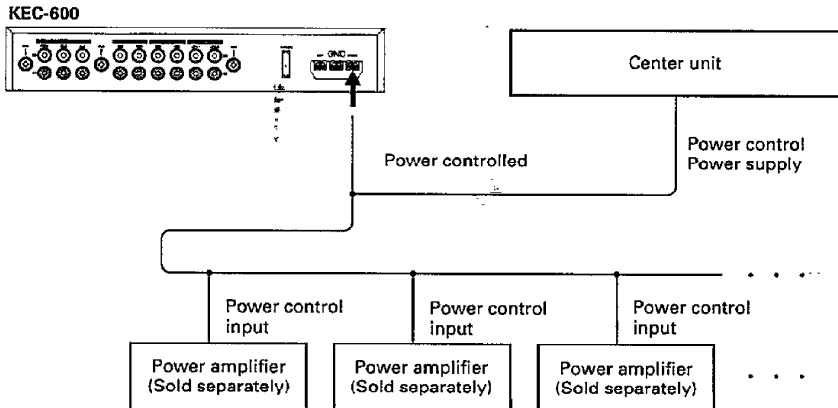

INSTALLATION

- When installing the acrylic panel, peel off the protective sheets from the two surfaces and attach so that the lines of the acrylic panel do not overlap with the control knobs on the control panel.

▲ CAUTION

- When installing to the car, install the unit securely for safety driving.
- Use screws supplied as accessories when installing the unit.

● Example 1

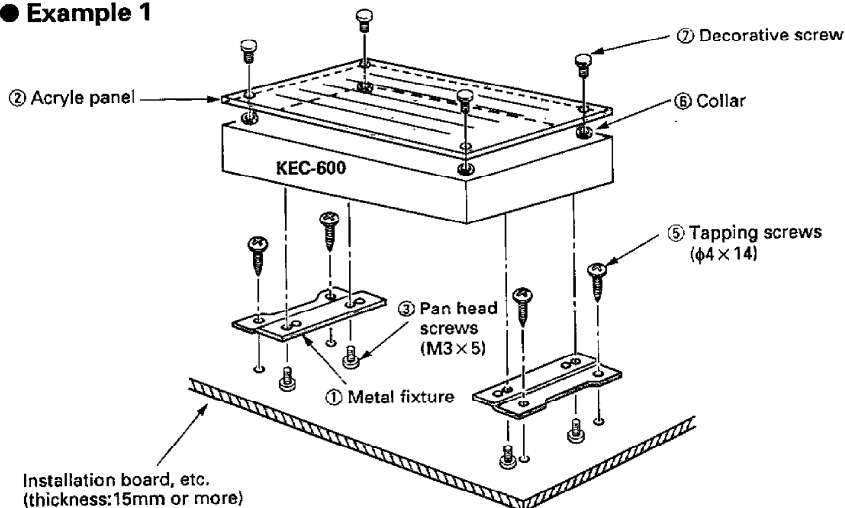

● Example 2

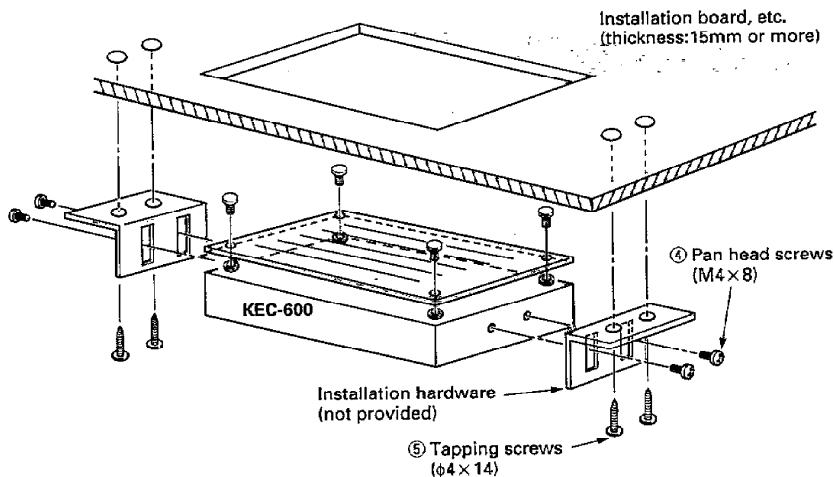

- An example of an installation position is inside a trunk room.

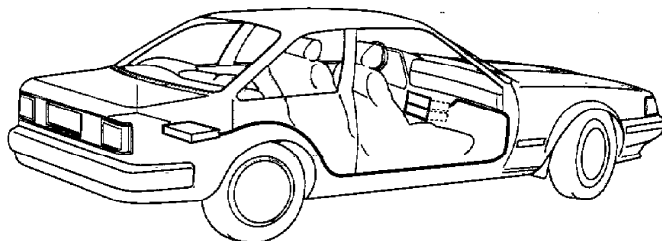

- Use the extension cables. (Optional)

	0.5 m	1 m	2 m	4 m	5 m	6 m
RCA	CA-2SL	CA-12SL	CA-22SL	—	CA-52SL	—
RCA (φ8 mm)	CA-3W	CA-13W	CA-23W	CA-43W	—	CA-63W
RCA (φ12 mm)	CA-5W	CA-15W	CA-25W	CA-45W	—	CA-65W

FRONT OUTPUT ADJUSTMENTS

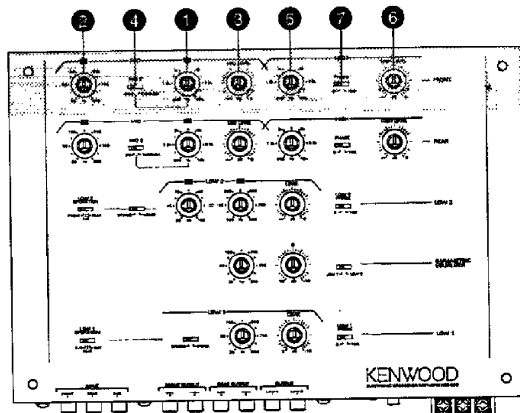

■ Middle frequency adjustments

❶ FRONT MID HIGH-CUT FREQUENCY CONTROL

Adjusts the high-cut frequency of the FRONT MID output.

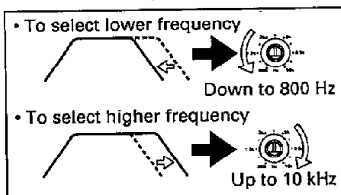

❷ FRONT MID LOW-CUT FREQUENCY CONTROL

Adjusts the low-cut frequency of the FRONT MID output.

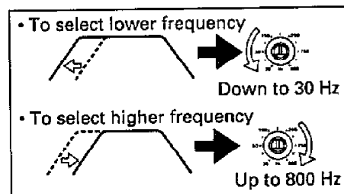

❸ FRONT MID OUTPUT LEVEL CONTROL

Adjusts the output level of the FRONT MID output.

❹ FRONT MID ON/THROUGH SWITCH

Switches the FRONT MID output between ON and THROUGH.

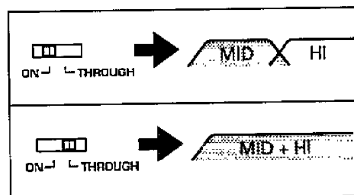

■ High frequency adjustments

❺ FRONT HIGH LOW-CUT FREQUENCY CONTROL

Adjusts the low-cut frequency of the FRONT HIGH output.

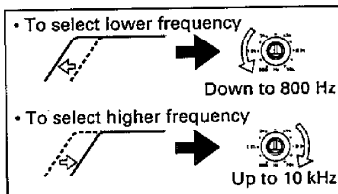

❻ FRONT HIGH OUTPUT LEVEL CONTROL

Adjusts the output level of the FRONT HIGH output.

❼ FRONT HIGH PHASE SWITCH

Switches the phase of the FRONT HIGH output by 180°.

REAR OUTPUT ADJUSTMENTS

ENGLISH

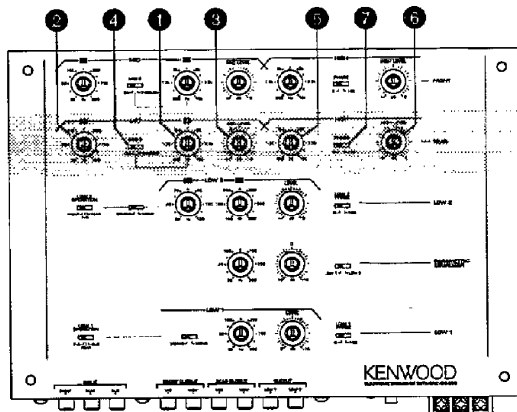

■ Middle frequency adjustments

① REAR MID HIGH-CUT FREQUENCY CONTROL

Adjusts the high-cut frequency of the REAR MID output.

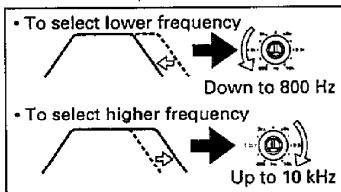

② REAR MID LOW-CUT FREQUENCY CONTROL

Adjusts the low-cut frequency of the REAR MID output.

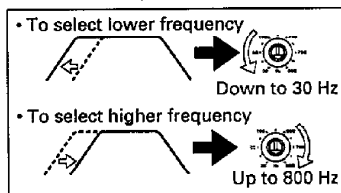

③ REAR MID OUTPUT LEVEL CONTROL

Adjusts the output level of the REAR MID output.

④ REAR MID ON/THROUGH SWITCH

Switches the REAR MID output between ON and THROUGH.

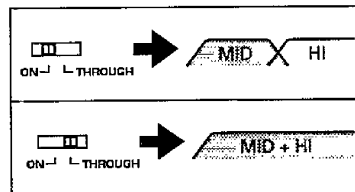

■ High frequency adjustments

⑤ REAR HIGH LOW-CUT FREQUENCY CONTROL

Adjusts the low-cut frequency of the REAR HIGH output.

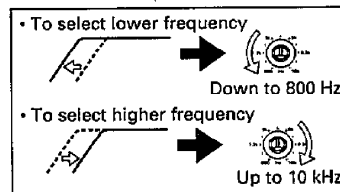

⑥ REAR HIGH OUTPUT LEVEL CONTROL

Adjusts the output level of the REAR HIGH output.

⑦ REAR HIGH PHASE SWITCH

Switches the phase of the REAR HIGH output by 180°.

LOW 2 OUTPUT ADJUSTMENTS

ENGLISH

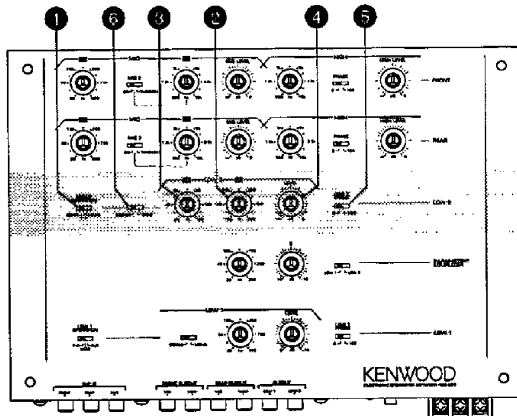

1 LOW 2 OPERATION SWITCH

Switches the output mode of the LOW 2 output.
3 modes, FRONT, REAR and F+R (non-fading) are available.

2 LOW 2 HIGH-CUT FREQUENCY CONTROL

Adjusts the high-cut frequency of the LOW 2 output.

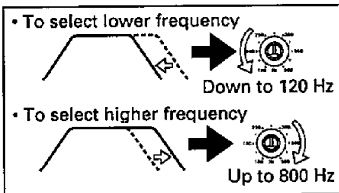

3 LOW 2 LOW-CUT FREQUENCY CONTROL

Adjusts the low-cut frequency of the LOW 2 output.

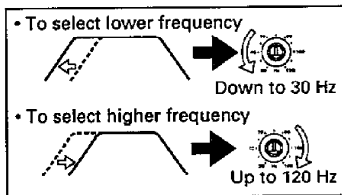

4 LOW 2 OUTPUT LEVEL CONTROL

Adjusts the output level of the LOW 2 output.

5 LOW 2 PHASE SWITCH

Switches the phase of the LOW 2 output by 180°.

6 LOW 2 MONO/STEREO SWITCH

Switches the LOW 2 output between MONO (monaural) and STEREO. The cut-off characteristic is 18 dB/oct. with MONO and 12 dB/oct. with STEREO.

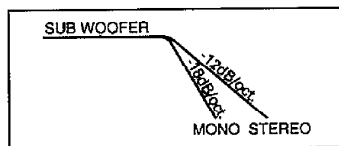

LOW 1 OUTPUT ADJUSTMENTS

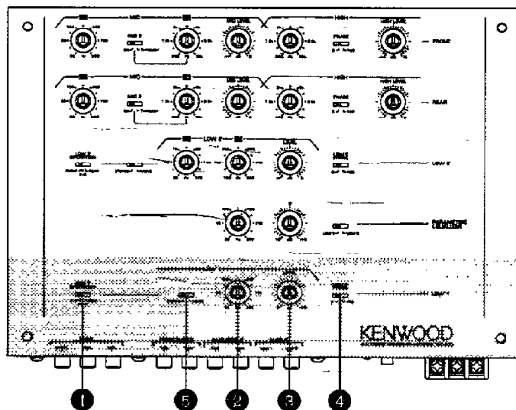

1 LOW 1 OPERATION SWITCH

Switches the output mode of the LOW 1 output.
3 modes, REAR, F+R (non-fading) and AUX are available.

2 LOW 1 HIGH-CUT FREQUENCY CONTROL

Adjusts the high-cut frequency of the LOW 1 output.

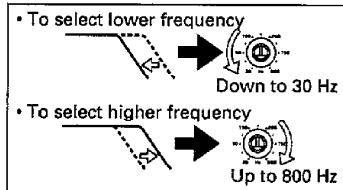

3 LOW 1 OUTPUT LEVEL CONTROL

Adjusts the output level of the LOW 1 output.

4 LOW 1 PHASE SWITCH

Switches the phase of the LOW 1 output by 180°.

5 LOW 1 MONO/STEREO SWITCH

Switches the LOW 1 output between MONO (monaural) and STEREO. The cut-off characteristic is 18 dB/oct. with MONO and 12 dB/oct. with STEREO.

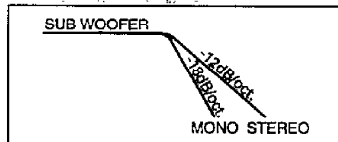

PARAMETRIC EQUALIZER ADJUSTMENTS

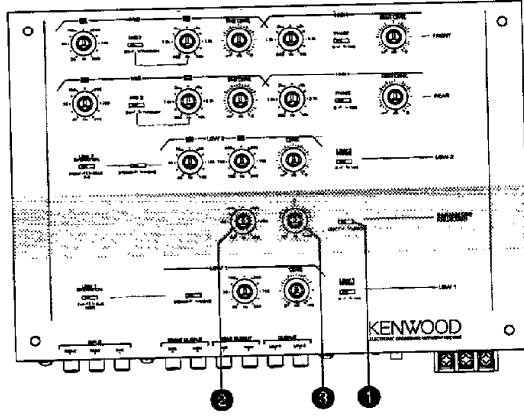

1 LOW 1/LOW 2 SWITCH

Switches the low-frequency output to be adjusted with the parametric equalizer (LOW 2 or LOW 1).

2 FREQUENCY CONTROL

Selects the frequency to be boosted or attenuated with the parametric equalizer.

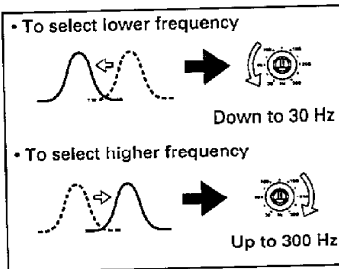

3 OUTPUT LEVEL CONTROL

Adjusts the output level of the frequency selected with the frequency control.

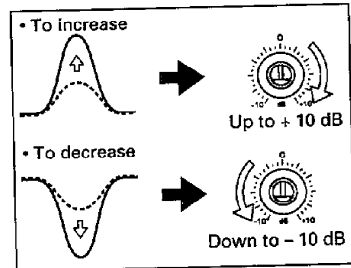

SPECIFICATIONS

Specifications subject to change without notice.

Crossover Section

R E A R			MID		HIGH
			Low cut	High cut	Low cut
	Crossover frequency (Variable)		30 Hz ~ 800 Hz	800 Hz ~ 10 kHz	800 Hz ~ 10 kHz
	Slope	Stereo	12 dB/oct.	12 dB/oct.	12 dB/oct.
		Mono.	_____	_____	_____
	Level		-∞ ~ 0 dB		-∞ ~ 0 dB
	Phase		_____		0/180°
Stereo/Mono.		Stereo		Stereo	
F R O N T			MID		HIGH
			Low cut	High cut	Low cut
	Crossover frequency (Variable)		30 Hz ~ 800 Hz	800 Hz ~ 10 kHz	800 Hz ~ 10 kHz
	Slope	Stereo	12 dB/oct.	12 dB/oct.	12 dB/oct.
		Mono.	_____	_____	_____
	Level		-∞ ~ 0 dB		-∞ ~ 0 dB
	Phase		_____		0/180°
Stereo/Mono.		Stereo		Stereo	
L O W			LOW 2		LOW 1
			Low cut	High cut	High cut
	Crossover frequency (Variable)		30 Hz ~ 120 Hz	120 Hz ~ 800 Hz	30 Hz ~ 800 Hz
	Slope	Stereo	12 dB/oct.	12 dB/oct.	12 dB/oct.
		Mono.	12 dB/oct.	18 dB/oct.	18 dB/oct.
	Level		-∞ ~ 0 dB		0 ~ +10 dB
	Phase		0/180°		0/180°
Stereo/Mono.		Stereo/Mono.		Stereo/Mono.	

Audio Section

Input Impedance.....	10 kΩ
Output Impedance.....	600 Ω
Signal to Noise Ratio.....	100 dB
T.H.D.....	0.01 %
Frequency Response.....	20 Hz ~ 100 kHz (-3 dB)
Parametric Equalizer Frequency.....	30 Hz ~ 300 Hz (Variable)
Parametric Equalizer Range.....	-10 ~ +10 dB

General

Operating Voltage.....	14.4 V (11~16 V)
Current Consumption (MAX.).....	0.3 A
Dimensions (W×H×D).....	280×50×200 mm (11×1-15/16×7-7/8 in.)
Weight.....	1.8 kg (4.0 lb)

KENWOOD